

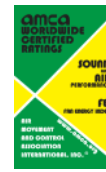

COOK



100V3B-19

Upblast Centrifugal Exhaust Ventilator Roof Mounted/Belt Drive

STANDARD CONSTRUCTION FEATURES:

All aluminum housing - Backward inclined all aluminum wheel - Two piece top cap with stainless steel quick release latches - One piece bottom spinning - Welded curb cap corners - Lifting Lugs - Permanently lubricated ball bearing motors - Oil and heat resistant, static conducting belts - Adjustable pitch drives through 5 hp motor - Corrosion resistant fasteners - Regreasable bearings in cast iron pillow block housing, rated at 200,000 hours average life - All fans factory adjusted to specified fan RPM - Transit tested packaging.

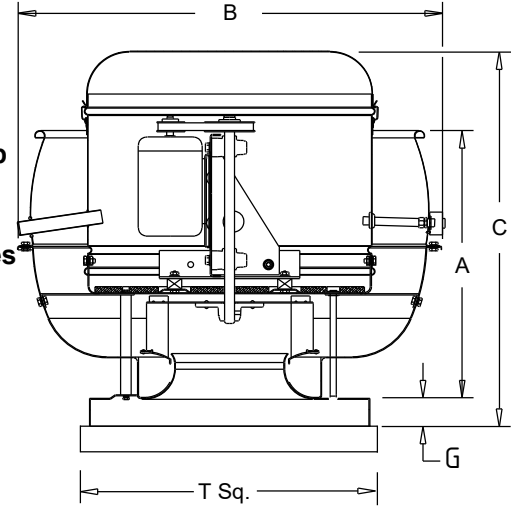

Performance (*Bhp includes 16% drive loss)

Qty	Catalog Number	Flow (CFM)	SP (inwc)	Fan RPM	Power* (HP)	FEG
1	100V3B-19	829	.625	1900	.242	n/a(<1HP)

Altitude (ft): 0 Temperature (F): 70

Motor Information

HP	RPM	Volts/Ph/Hz	Enclosure	FLA	Mounted
1/4	1725	115/1/60	ODP -SE	5.8	Yes

FLA based on NEC (2017) Table 430.248

Sound Data Inlet Sound Power by Octave Band

1	2	3	4	5	6	7	8	LwA	dBA	Sones
73	77	80	76	68	64	58	53	76	65	12.8

- Distance from Sound source 5 ft

Accessories:

DRIVES (1.5 SF) @ 1900 RPM
UL762 (327Y-300DEG)

Dimensions (inches)

A	12-1/2
B	25-1/4
C	20-3/16
G	2
T Sq.	19
Roof Open. Sq.*	13-1/2

NOTE: Accessories may affect dimensions shown.

Weight(lbs)***	Shipping	84	Unit	74
----------------	----------	----	------	----

* Roof opening size for curbs supplied by Cook only.

***Includes fan, motor & accessories.

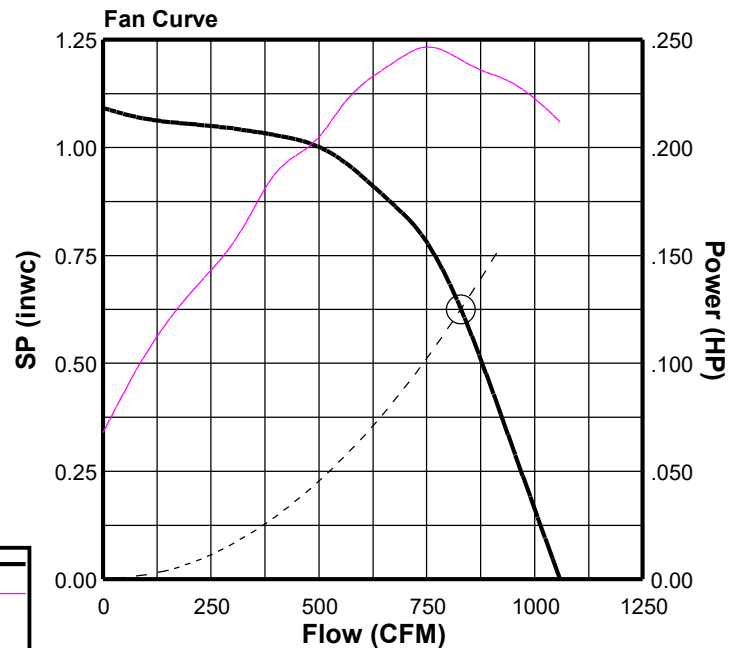

Fan Curve Legend

CFM vs SP	—
CFM vs HP	—
Point of Operation	○
System Curve	- - -